

REV.	DESCRIPTION	DATE
A	NEW DRAWING	6/4/2007
B	cone gap diagram added	10/21/2008

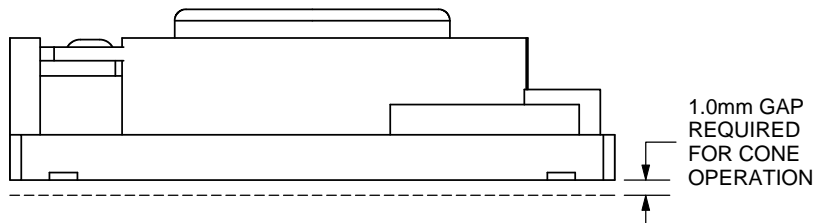

TOLERANCE:
±0.5mm UNLESS OTHERWISE
SPECIFIED

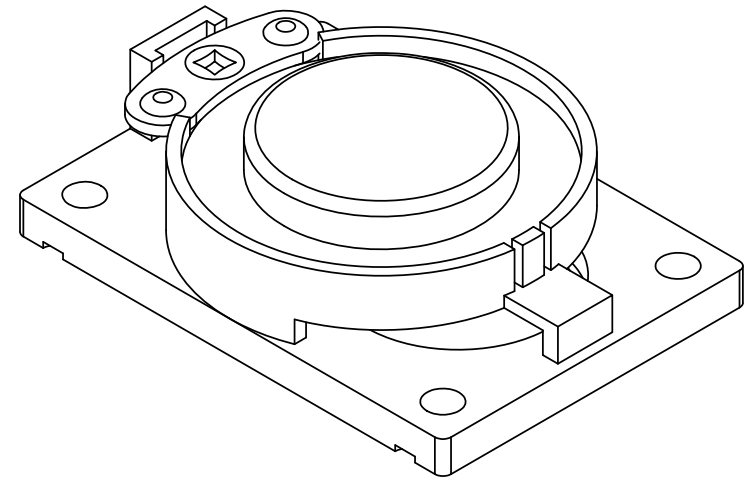
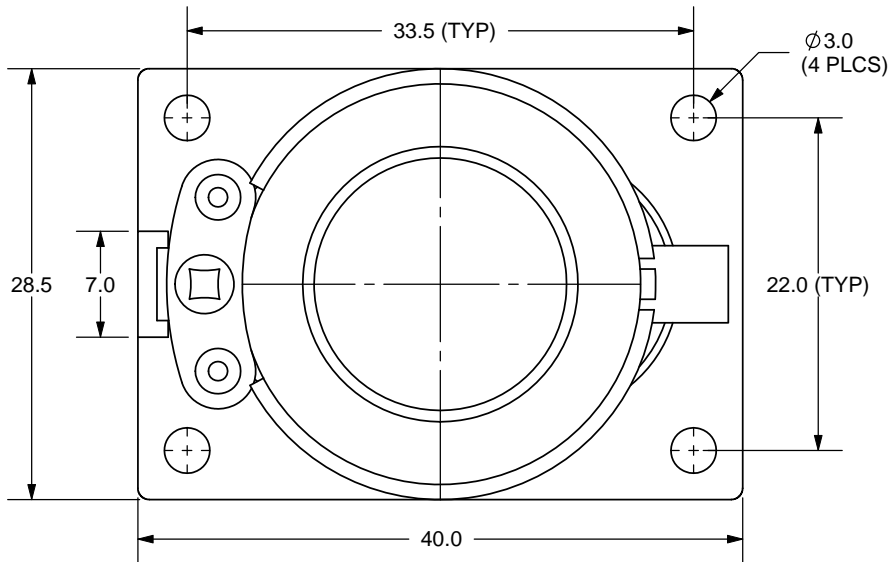
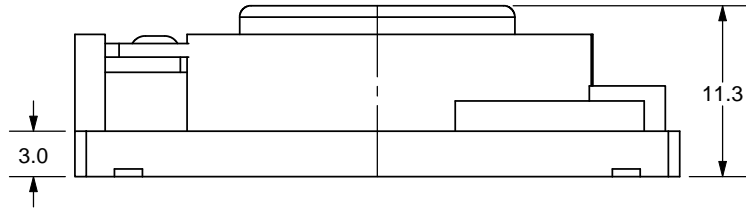

20050 SW 112th Ave.
Tualatin, OR 97062
Phone: 503-612-2300
800-275-4899
Fax: 503-612-2383
Website: www.cui.com

TITLE: LOW PROFILE NOTEBOOK SPEAKER		REV: B
PART NO. GC0401K	UNITS: MM [INCHES]	
DRAWN BY: ZRJ	APPROVED BY:	SCALE: 2:1

PC FILE NAME:
GC0401K

COPYRIGHT 2008 BY CUI INC.